

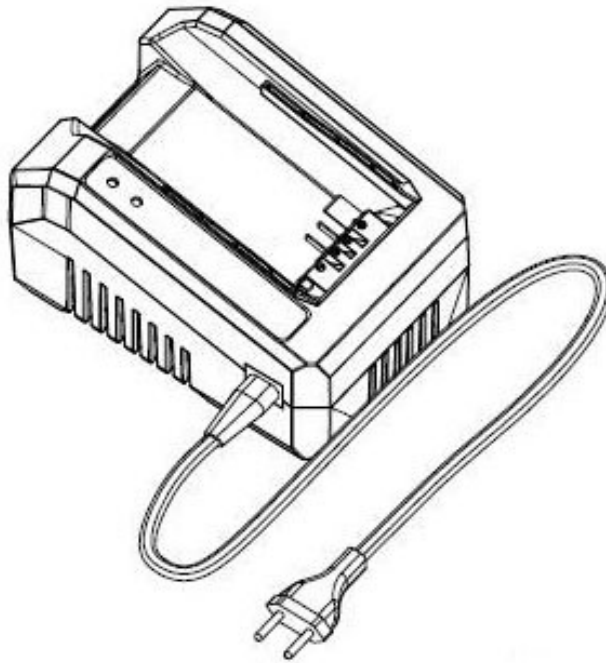

OPERATOR'S MANUAL

Model ZBCH5817

58 Volt Battery Charger for use with
ZOMBI™ 58 VOLT LITHIUM Battery Pack



SPECIFICATIONS:	
Input	120 Volts, 60 Hz, 1.5 Amperes, AC Only
Charging Voltage	58 Volt
Charging Current	2 Amperes
Net Weight	1.79 Lbs



CA Compliant charger included, model No. ZBCH5817.

THANK YOU FOR PURCHASING AN ZOMBI™ LITHIUM BATTERY CHARGER.

Your new battery charger has been engineered and manufactured to our high standard for dependability, ease of operation, and operator safety. Properly cared for, it will give you years of rugged, trouble-free performance.

DO NOT RETURN THIS PRODUCT TO THE STORE. OPERATING, ASSEMBLY, PARTS, SERVICE QUESTIONS?
CALL 1-800-313-5111 BETWEEN 8:00 AM—5:00 PM EST FOR ASSISTANCE.

⚠ CAUTION: Carefully read through this entire operator's manual before using your new battery charger.





Pay close attention to the Rules for Safe Operation, Warnings, and Cautions. If you use your battery charger properly and only for what it is intended, you will enjoy years of safe, reliable service.

SAVE THIS MANUAL FOR FUTURE REFERENCE

RULES FOR SAFE OPERATION

The purpose of safety symbols is to attract your attention to possible dangers. The safety symbols and the explanations with them, deserve your careful attention and understanding. The safety warnings do not by themselves eliminate any danger. The instructions or warnings they give are not substitutes for proper accident prevention measures.

SYMBOL MEANING

	SAFETY ALERT SYMBOL: Indicates danger, warning, or caution. May be used in conjunction with other symbols or pictographs.
	DANGER: Failure to obey a safety warning will result in serious injury to yourself or to others. Always follow the safety precautions to reduce the risk of fire, electric shock and personal injury.
	WARNING: Failure to obey a safety warning can result in serious injury to yourself or to others. Always follow the safety precautions to reduce the risk of fire, electric shock and personal injury.
	CAUTION: Failure to obey a safety warning may result in property damage or personal injury to yourself or to others. Always follow the safety precautions to reduce the risk of fire, electric shock and personal injury.
NOTE: Advises you of information or instructions vital to the operation or maintenance of the equipment.	

 **WARNING:**
Do not attempt to operate this battery charger until you have read thoroughly and understand completely all instructions, safety rules, etc. contained in this manual. Failure to comply can result in accidents involving fire, electric shock, or serious personal injury. Save this operator's manual and review frequently for continuing safe operation, and instructing others who may use this battery charger.

- To reduce risk of damage to charger body and cord, pull by plug body rather than cord when disconnecting charger.
- Make sure cord is located so that it will not be stepped on, tripped over, or otherwise subjected to damage or stress.
- An extension cord should not be used unless absolutely necessary. Use of improper extension cord could result in a risk of fire and electric shock. If extension cord must be used, make sure:
 - a. That pins on plug of extension cord are the same number, size and shape as those of plug on charger.
 - b. That extension cord is properly wired and in good electrical condition; and
 - c. That wire size is large enough for AC ampere rating of charger as specified below:

IMPORTANT SAFETY INSTRUCTIONS FOR CHARGER

- **SAVE THESE INSTRUCTIONS.** This manual contains important safety and operating instructions for model ZBCH5817.
- Before using battery charger, read all instructions and cautionary markings on battery charger, and product using battery charger. Carefully read and understand these instructions and the Operator's Manual for the product using this charger.

 **WARNING:** To reduce risk of injury, charge only ZOMBI™ Lithium 58V lithium-ion type rechargeable batteries. Other types of batteries may burst causing personal injury and damage.

- Do not expose charger to rain or snow or other wet conditions.
- Use of an attachment not recommended or sold by the battery charger manufacturer may result in a risk of fire, electric shock, or injury to persons.

RECOMMENDED MINIMUM A.W.G. SIZE FOR EXTENSION CORDS FOR BATTERY CHARGERS		
Ampere Rating (on face plate)	0 - 2.0	2.1 - 3.4
Cord Length (Feet)	Wire Size (A.W.G.)	
25'	16	16
50'	16	16
100'	16	16
NOTE: AWG = American Wire Gage		

RULES FOR SAFE OPERATION

- **DO NOT OPERATE CHARGER WITH A DAMAGED CORD OR PLUG.** If damaged, call our customer service help line at 1-800-313-5111 for assistance.
- Do not operate charger if it has received a sharp blow, been dropped, or otherwise damaged in any way; call our customer service help line at 1-800-313-5111 for assistance..
- Do not disassemble charger; when service or repair is required call our customer service help line at 1-800-313-5111 for assistance. Risk of electric shock or fire may result if reassembled incorrectly.
- To reduce risk of electric shock, unplug charger from outlet before attempting any maintenance or cleaning. Turning off controls will not reduce this risk.
- Do not use charger outdoors.
- Disconnect charger from power supply when not in use.

PRECAUTIONS REGARDING THE USE OF CHARGER AND BATTERY

- Do not charge battery when temperature is below 32°F or above 100°F.
- Never attempt to connect two chargers together.
- The charger is designed to operate on standard household electrical power. Do not attempt to use it on any other voltage.
- Do not insert foreign matter into the hole for the battery in charger.

- Do not charge by means of an engine generator or DC power source.
- Do not disassemble the battery.
- Do not store the tool and battery in locations where the temperature may reach or exceed 104°F (40°C) such as outside sheds or metal buildings in summer.
- Do not incinerate the battery, even if it is severely damaged or completely worn out. The battery may explode in fire.
- Under extreme usage or temperature conditions, battery leakage may occur. If liquid comes in contact with your skin, wash immediately with soap and water, then neutralize with lemon juice or vinegar. If liquid gets in your eyes, flush them with clean water for at least 10 minutes, then seek immediate medical attention.
- Do not short-circuit the battery.
- Do not discharge battery beyond normal use limits. Further discharging (such as by placing a rubber band on the trigger switch) can cause a deep discharge which may result in polarity reversal of a cell rendering the battery useless.



WARNING: California Proposition 65:

The electrical cord on this product may contain chemicals known to the State of California to cause cancer and birth defects or other reproductive harm. Wash hands after handling.



WARNING: Cancer and Reproductive Harm - www.P65Warnings.ca.gov.

SAVE THESE INSTRUCTIONS



Look for this symbol to point out important safety precautions. It means attention!!!
Your safety is involved.

OPERATION

USE THIS BATTERY CHARGER ONLY WITH ZOMBI™ 58V LITHIUM-ION BATTERY PACKS.

CHARGING BATTERY PACK

Battery packs are shipped in a low charge condition to prevent possible problems. Therefore, you should charge them prior to use.

NOTE: Batteries will not reach full charge the first time they are charged. Allow several cycles (operating tool followed by recharging batteries) for them to fully charge.

TO CHARGE

- Use this battery charger only with ZOMBI™ Lithium 58V lithium-ion battery packs.
- Make sure power supply is normal house voltage, 120 volts, 60 Hz, AC only.
- Connect the power cord as shown in Fig. 1. Use only the cord provided. Other cord may not fit properly causing unsafe situation.
- Connect charger to power supply. The light will be **constant red** indicating that the power is on.
- Slide battery pack into charger. (Fig. 2)
- Press down on battery pack to be sure contacts on battery pack engage properly with charger contacts.
- Charger lights will be illuminated. (Fig. 3)
A constant **RED** light and a flashing green light indicates the battery is charging.
Constant **RED AND GREEN** lights indicate the battery is fully charged.
- The battery pack will become slightly warm to the touch while charging. This is normal and does not indicate a problem.

- **DO NOT** place charger in an area of extreme heat or cold. It will work best at normal room temperature.
- When the battery is fully charged, unplug your charger from power supply and remove the battery pack.
- Charge time is dependent upon the type of battery pack.
ZB2AH5817 charges in approximately 60 minutes.
ZB4AH5817 charges in approximately 120 minutes.

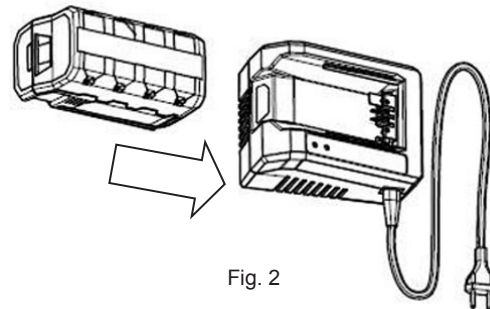
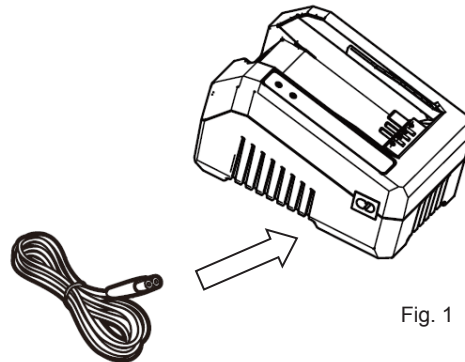

Battery Pack

Constant Red + Flash Green = Battery is charging
Constant Red + Constant Green = Battery is fully charged

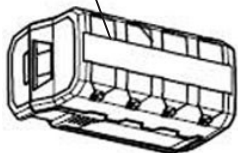
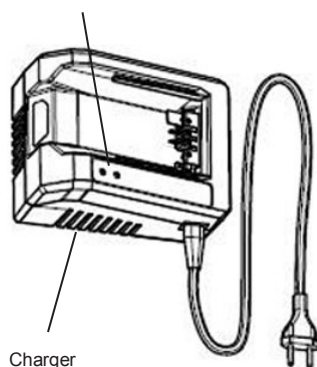
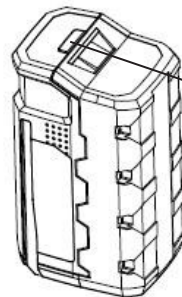

Fig. 3



Charger



Button—press to check battery's capacity and temperature.

Fig. 4

OPERATION

LED FUNCTION OF CHARGER			
Battery Pack / Charger	Green LED	Red LED	Action
Charging	Flashing	On	Battery is being charged.
Battery fully charged / Energy save mode	On	On	Charging is complete; charger maintains charge mode / turns to Energy Save mode.
Hot battery pack	Flashing	Flashing	When battery pack reaches cooled temperature, charger begins charge mode.
Cold battery pack			When battery pack reaches warmed temperature, charger begins charge mode.
Deeply discharged			Charger conditions battery until normal voltage is reached, then begins charge mode.
Defective battery	Off	Flashing	<ul style="list-style-type: none"> • If defective, try to repeat the conditions a second time by removing and reinstalling the battery pack. If the LED status repeats a second time try charging a different ZOMBI 58 Volt battery. • If a different battery charges normally, properly dispose of the defective battery pack. • If a different battery also indicates “defective”, the charger may be defective.
Defective charger	Off	Off	No light indicates the charger may be defective

LED FUNCTION OF BATTERY PACK:

The battery is equipped with a digital display which shows the battery capacity up to 99% and the battery temperature (Celsius). (Fig.4)

- To check battery capacity, press the LED button once. To check battery temperature, press LED button twice. The lights will automatically shut off after 3 to 5 seconds.
- Battery capacity reading will show a maximum of 99% on the screen.
- When battery pack reaches 70 °C, the built in thermal protection will stop the unit to protect the battery from damage. Remove the battery pack from the unit and allow it to cool to below 50°C. Once the battery has cooled, you may reinsert the battery and resume the job.
- During charging, if battery temperature reaches 50°C, the thermal protection will be activated and charging will be halted. When battery cools to less than 45°C, charging will resume. It is advisable to remove the battery from the charger and allow ample time for cooling so the battery can be fully charged without interruption.
- If battery temperature is below 0°C, battery cannot be charged. Charging will begin when battery warms to over 5°C.

OPERATION

Charging a Hot Battery Pack

When using a tool continuously, the battery pack may become hot. A hot battery pack may be placed directly onto the charger port but charging will not begin until the battery temperature cools to within acceptable temperature range. When a hot battery pack is placed on the charger, the red and green LED lights will be flashing alternatively. When the battery pack cools, the charger will automatically begin charging. It is advisable to remove the battery from the charger and allow ample time for cooling so the battery can be fully charged without interruption.

Charging a Cold Battery Pack

A cold battery pack may be placed directly onto the charger port but charging will not begin until the battery temperature warms to within acceptable temperature range. When a cold battery pack is placed on the charger, the red LED and green LED will be flashing. When the battery pack warms, the charger will automatically begin charging.

After the battery has been fully charged, the LED lights will remain on until the charger is disconnected from the power source. Output current from the charger stops an hour after the battery is fully charged.

MAINTENANCE

WARNING:

 When servicing, use only identical replacement parts. Use of any other part may create a hazard or cause product damage.

DO NOT abuse power tools. Abusive practices can damage tools as well as the workplace.

WARNING:

 Do not at any time let brake fluids, gasoline, petroleum-based products, penetrating oils, etc. come in contact with plastic parts. They contain chemicals that can damage, weaken or destroy plastic.

WARNING:

 Do not attempt to modify or create accessories not recommended for use with this charger. Any such alteration or modification is misuse and could result in a hazardous condition leading to possible serious personal injury.

• SERVICE

Now that you have purchased your charger, should a need ever exist for repair parts or service, simply contact us at 1-800-313-5111. Be sure to provide all pertinent facts when you call or visit.

• MODEL NUMBER

The model number will be found on a plate attached to the bottom of the housing.

• NAME OF ITEM BATTERY CHARGER

• MODEL NUMBER ZBCH5817

• SERIAL NUMBER _____



OPERATOR'S MANUAL

58 Volt Battery Charger for use with ZOMBI™ 58VOLT LITHIUM Battery Pack

WARRANTY POLICY

Five (5) year limited warranty on ZOMBI 58 volt outdoor power equipment and two (2) year limited warranty on ZOMBI 58 volt battery packs and chargers.

ZOMBI warrants to the original owner that each new product and service part is free from defects in materials and workmanship and agrees to repair or replace any defective product or part for the warranty period as stated above from the original date of purchase except for the conditions and circumstances listed below:

This warranty applies only to the original purchaser at retail and may not be transferred.

Warranty applies if the product is used for personal, household or family use. Warranty is void if product is used for commercial, industrial or rental purposes.

Warranty does not include repairs necessary due to operator's abuse or negligence (including overloading the product beyond capacity or immersion in water), or the failure to assemble, operate, maintain or store the product according to the instructions in the operator's manual.

This warranty is not transferable and only applies to product sold directly from an authorized retailer. This warranty does not apply to any product, new or used, purchased through unauthorized third-party channels.

ANY INCIDENTAL, INDIRECT OR CONSEQUENTIAL LOSS, DAMAGE, OR EXPENSE THAT MAY RESULT FROM ANY DEFECT, FAILURE OR MALFUNCTION OF THE PRODUCT IS NOT COVERED BY THE WARRANTY. Some states do not allow the exclusion or limitation on how long an implied warranty lasts, so the above limitation may not apply to you.

Products sold damaged or incomplete, sold "as is", or sold as reconditioned are not covered under the warranty.

Damage or liability caused by shipping, improper handling, improper assembly, incorrect voltage, improper wiring, improper maintenance, improper modification or the use of accessories and/or attachments not specifically recommended is not covered by this warranty.

Expendable items that become worn during normal use are not covered by the warranty.

Warranty does not cover damage caused by cold, heat, rain, excessive humidity, corrosive environments and materials, or other contaminants. Warranty does not include installation, assembly or normal adjustments explained in the operator's manual.

The expense of delivering the product to the vendor and the expense of returning the product or replacement parts to the owner is not covered by the warranty.

The warranty does not cover normal deterioration of the exterior finish, including but not limited to scratches, dents, paint chips or any corrosion or discoloration caused by heat, abrasive and chemical cleaners.

Proof of purchase, original dated sales receipt, must accompany all warranty claims.



American Lawn Mower Company
The Great States Corporation
7444 Shadeland Station Way
Indianapolis, IN 46256 USA
Phone 1-800-313-5111
www.earthwisetools.com

In a continued commitment to improve quality, the Manufacturer reserves the right to make component changes or design changes when necessary.